

# L3

All-In-One Liquid Cooler

---

Installation Guide

# Box Contents



A. L3 Liquid Cooler

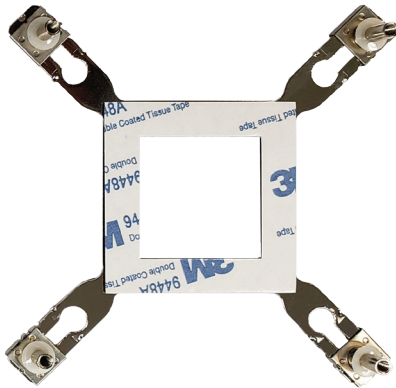

B. Intel Backplate

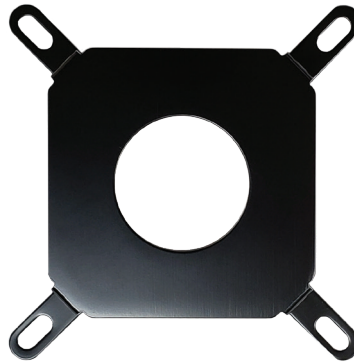

C. Intel Retention Bracket

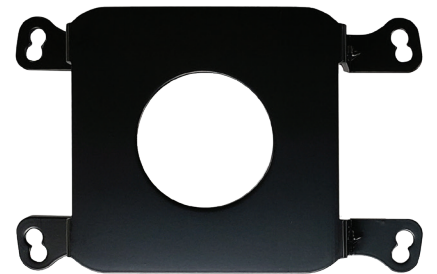

D. AMD Retention Bracket



E. AMD Screws



F. Intel 775/115X /1200 /1356/1366/1700 Screws



G. Intel 2011/2066 Screws



H. Extra Screws



I. Extra Screws

# Intel Installation

## STEP 1

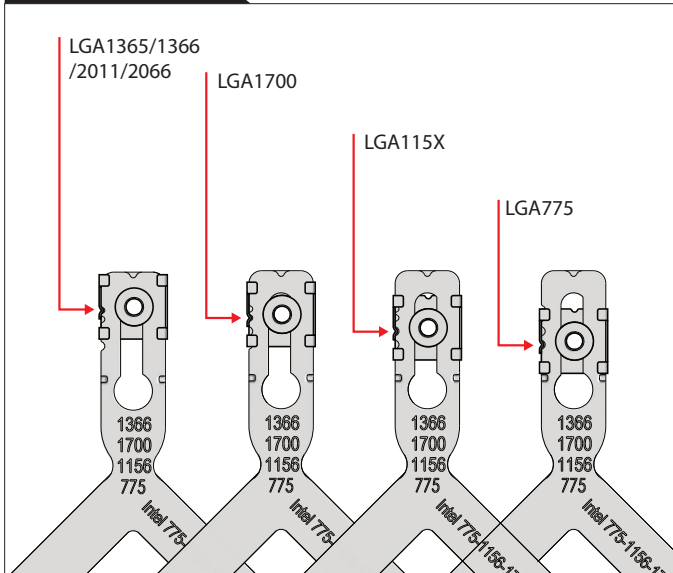

Select the proper Intel Socket from Intel backplate

## STEP 2

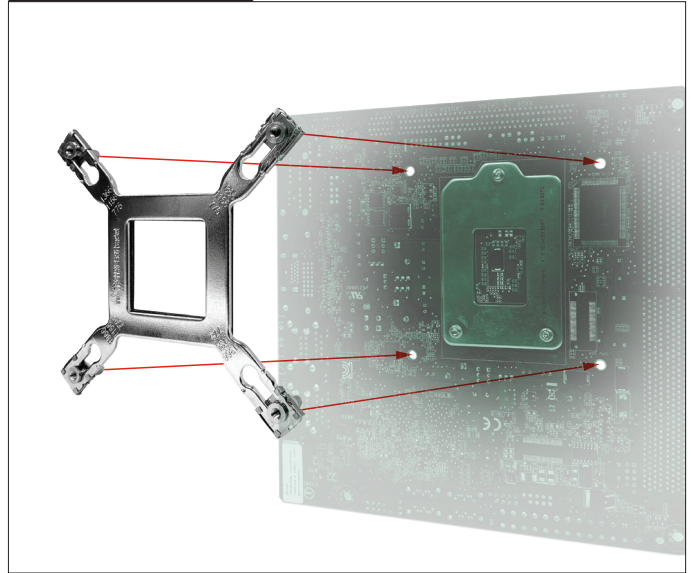

Align the backplate on the back of the motherboard

## STEP 3



Peel off 3M backing

## STEP 4

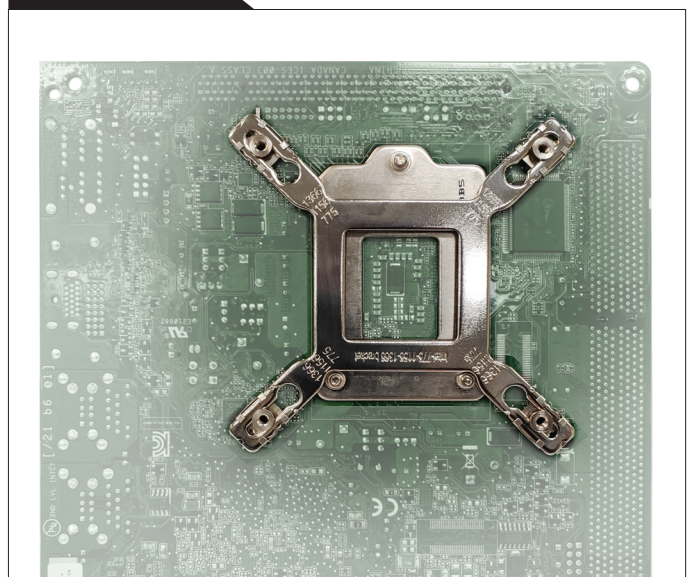

Affix the backplate to the back of the motherboard

# Intel Installation

## STEP 5



Slide the retention Ring to the cold plate

## STEP 6

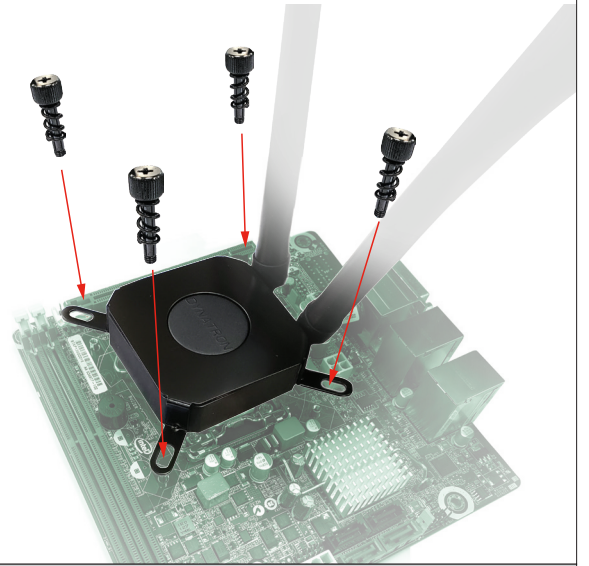

Position the cold plate over the CPU, Tighten the screws

## STEP 7

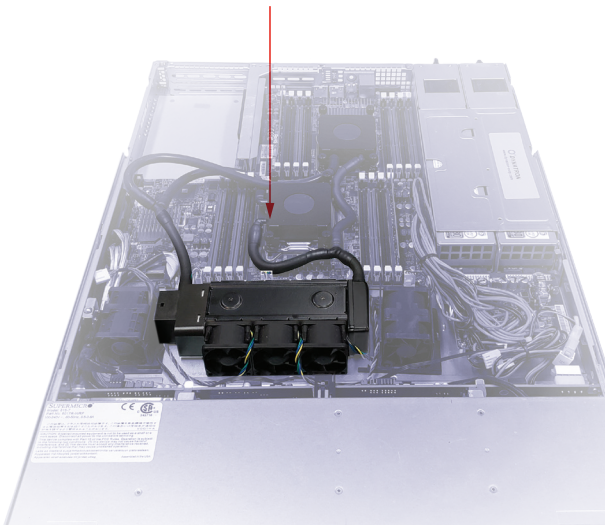

Place or mount the radiator and fan to the chassis

## STEP 8

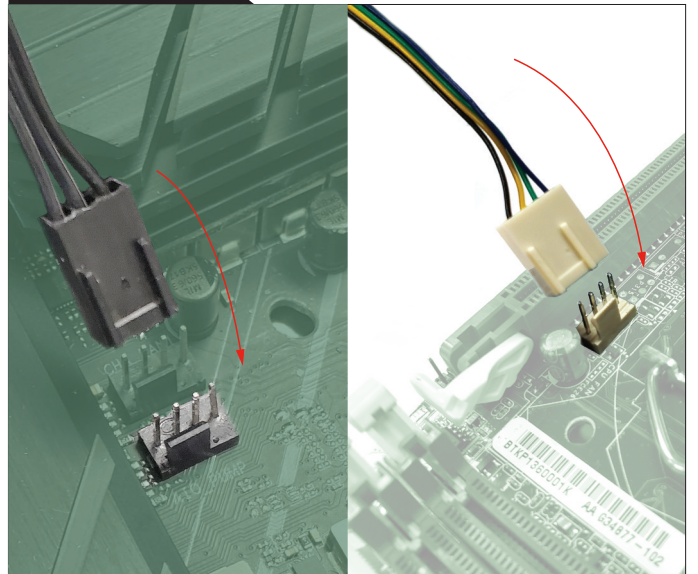

Connect the power connectors to the motherboard's PUMP and CPU fan header



# AMD Installation

## STEP 1

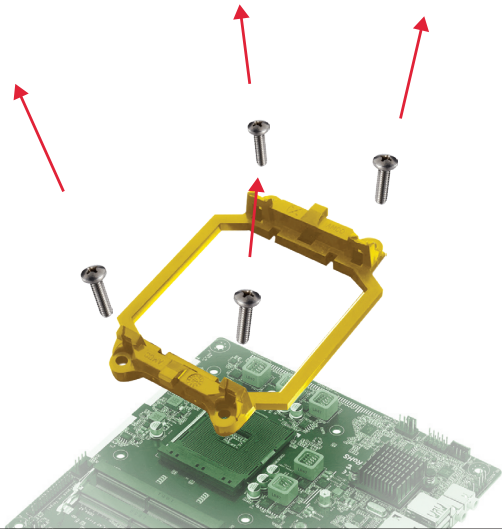

Remove AMD retention from the motherboard

## STEP 2

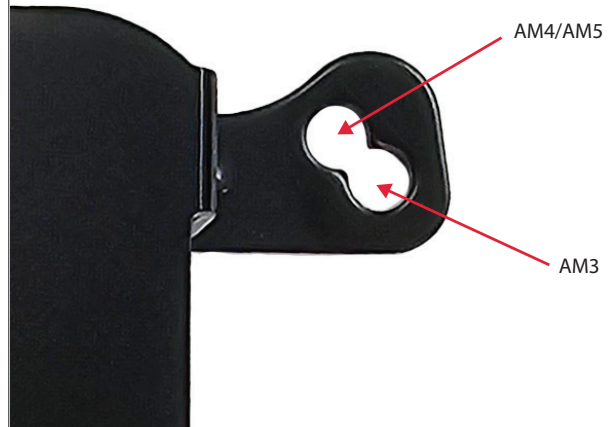

Select proper socket solution

## STEP 3

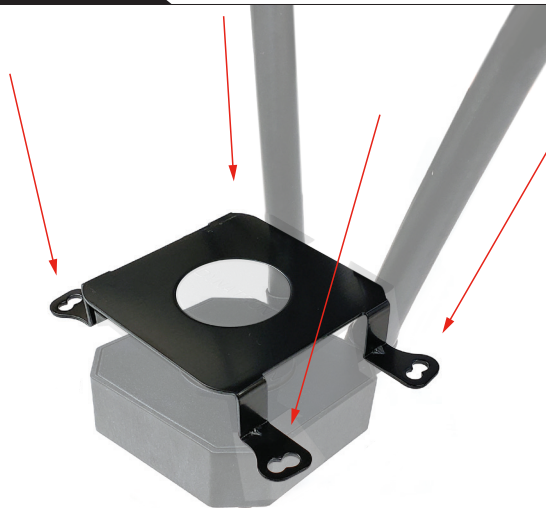

Locate AMD retention bracket on the cold plate

## STEP 4

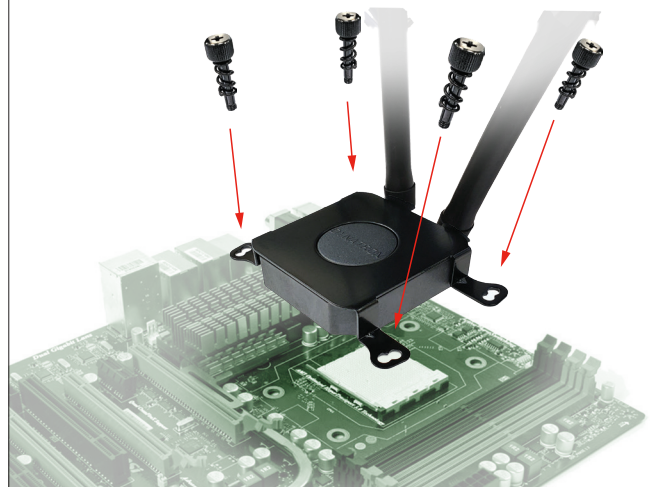

Tighten the screws into the proper holes based on the CPU socket you use

# AMD Installation

## STEP 5

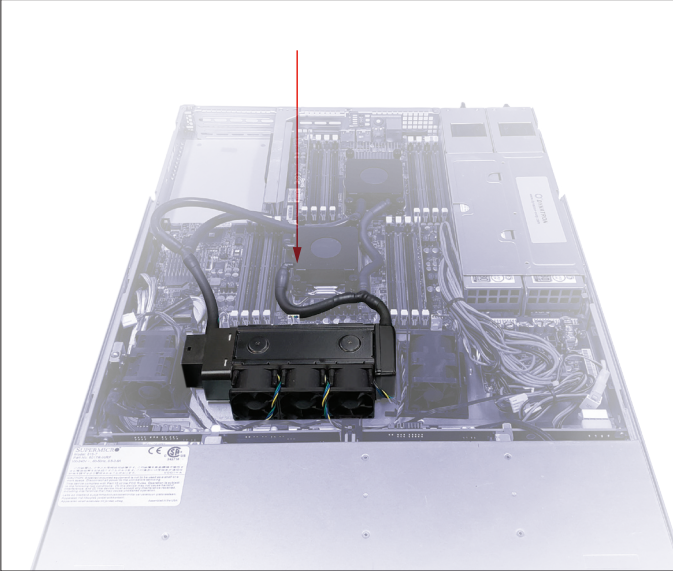

Place or mount the radiator and fan to the chassis

## STEP 6

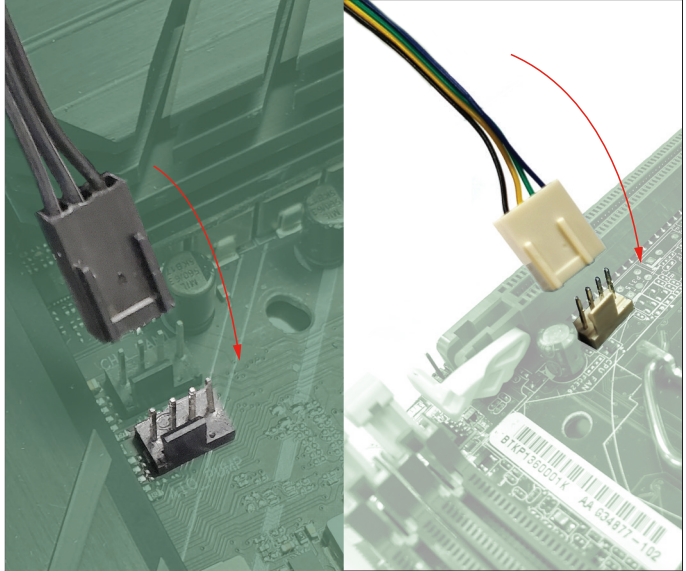

Connect the power connectors to the motherboard's PUMP and CPU fan header